

DPAE-SDDE-Pro is a high performance new X-ray Silicon Drift Detector, can realize the high resolution at a low forming time.

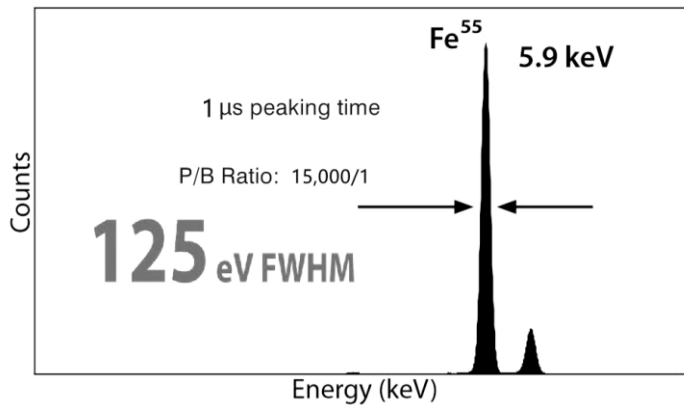
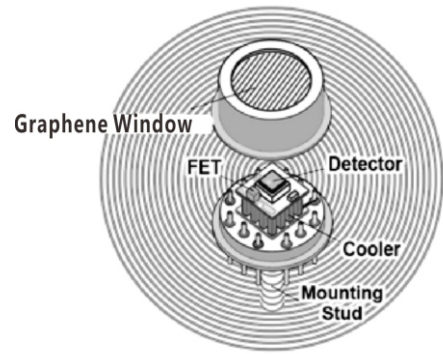
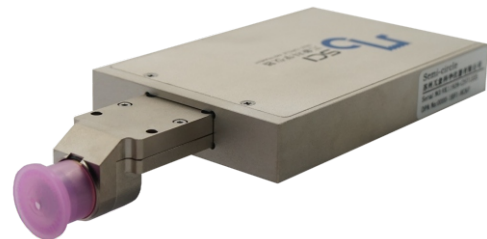

Figure 1. Fe55 Spectrum with DPA-SDDE20-Pro Detector



## Features:

- 125eV FWHM Resolution @ 5.9 keV
- High Peak-to-Background Ratio 15,000:1
- Size: 20/30/50 mm<sup>2</sup>
- Thickness: 450 μm
- 1 μs Peaking Time (Max cooling)
- Max. input count rate: 2000KCPS
- Interface : USB, RS232, Ethernet
- No Liquid Nitrogen



DPAE-SDDE-Pro Includes:

- 1 Silicon Drift Detector and Preamplifier
- 2 Digital Pulse Analyzer (with Power)

## Applications:

- X-Ray Fluorescence
- RoHS / WEEE Compliance XRF
- OEM & Special Applications
- Process Control
- Research

## General Specifications

Detector Type	DPAE-SDDE-Pro (Silicon Drift Detector)
Detector Size	20mm <sup>2</sup> / 30mm <sup>2</sup> / 50mm <sup>2</sup> (Optional)
Silicon Thickness	450μm
Energy Resolution @5.9keV(Fe55)	125–140eV FWHM at 1μs peaking time
Peak to Background	15000:1
Detector Window Thickness	1.0μm (See Figure 5)
Collimator	Internal Multi Layer Collimator (ML)
Charge Sensitive Preamplifier	custom design with reset
Gain Stability	<20 ppm/°C (typical)
Case Size	See the Size Drawing
Weight	About 200g
Total Power	4.2-8.5VDC
Warranty Period	1 year
Lifetime Typical	5 to 10 years, depending on use
Storage & Shipping	Long-term Storage: 10+ years in dry environment Typical Storage & Shipping: -20°C to+50°C, 10 to 90% humidity Operation conditions noncondensing
Operation conditions	0°C -50°C

This DPAE-SDDE-Pro enables extremely high count rate applications with excellent energy resolution; its high performance, small size make it the ideal detector for OEM hand-held applications to bench-top analyzers.

### Use of Collimators

Most of detectors contain internal collimators to improve spectral quality. X-rays interacting near the edges of the active volume of the detector may produce small pulses due to partial charge collection.

For some applications, these pulses result in artifacts in the spectrum which obscure the signal of interest. The internal collimator restricts X-rays to the active volume, where clean signals are produced. Depending on the type of detector, collimators can improve peak to background(P/B), eliminate edge effects, and eliminate false peaks.

## Additional System Information and Performance

Resolution for Different Peaking Times

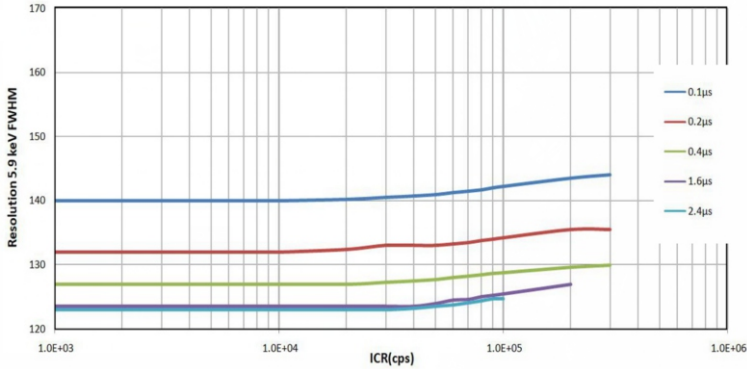

Figure 2. Resolution VS Input Count Rate (with different peaking time)

Throughput

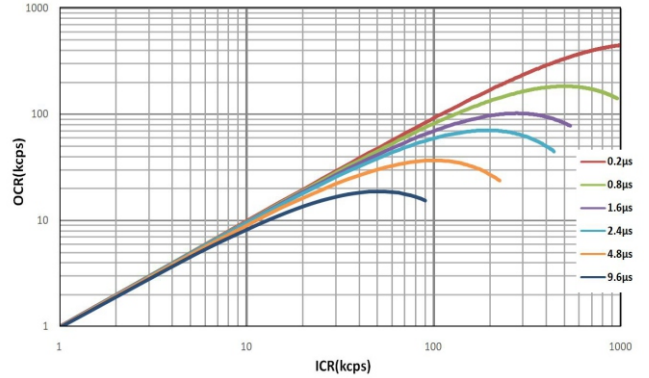

Figure 3. OCR VS ICR (with different peaking time)

Resolution vs Peaking Time

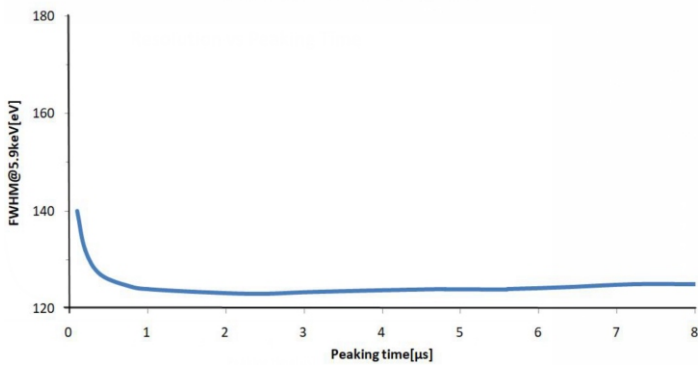

Figure 4. Resolution VS Peaking Time

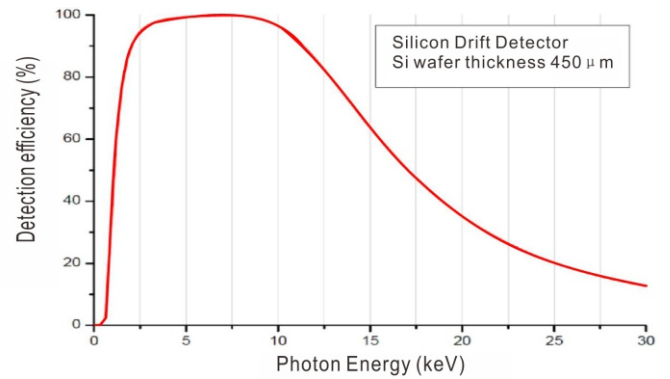
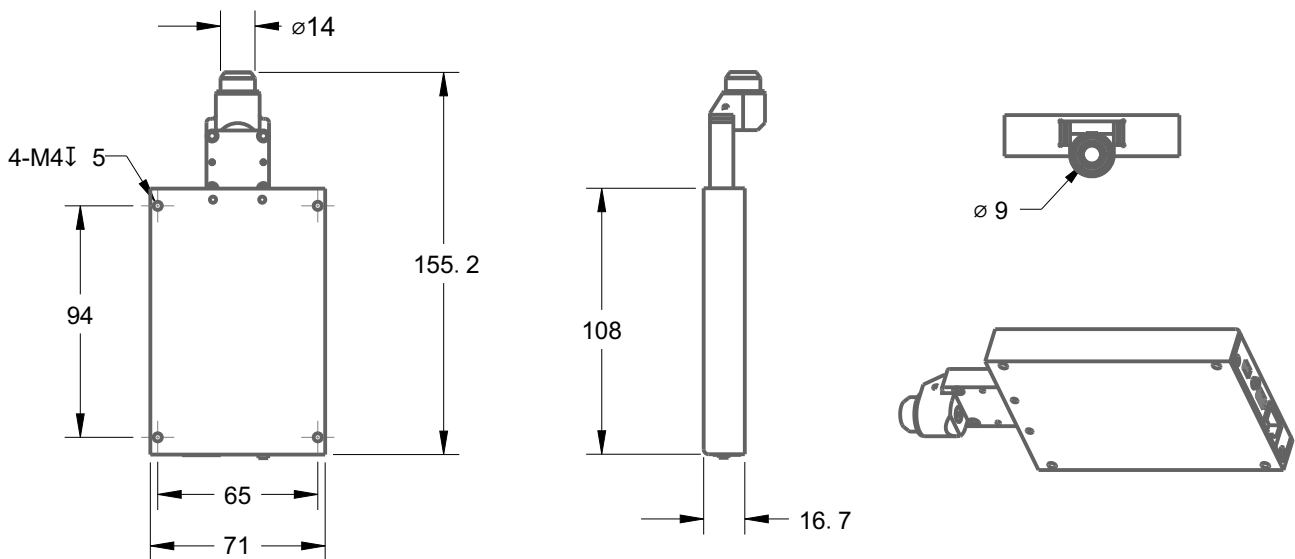

Figure 5. Efficiency and Transmission

SIZE (mm)



## Application Spectra

